

Assemble manual

STEP 1

Select a flat ground for the tent, unpack the carton and check all the parts including tubes, tent and accessories... etc. are present as same as list.

Assemble the framework of rooftop by joining the portion (5.6.7.8.9.) together with poles (1.2). To ensure the screw and turn buckle fixed to every pole tightly .

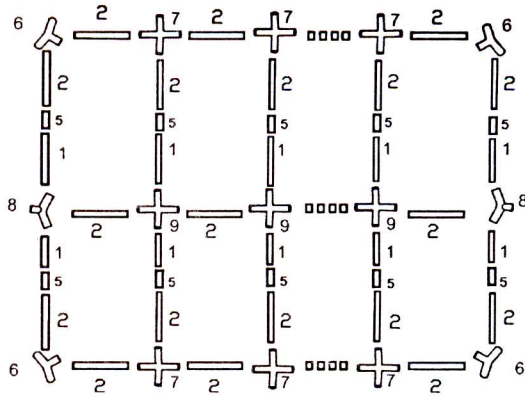

STEP 2

Attach one end of supported pole (4) to the joints (6.7)

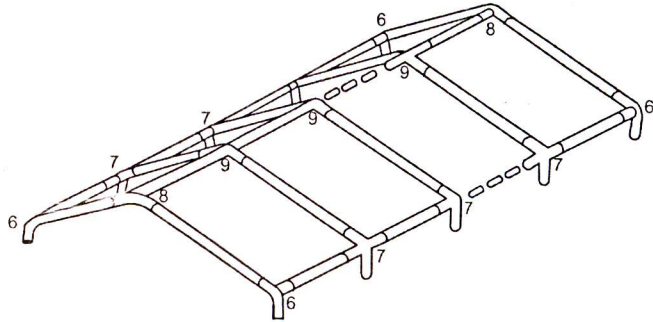

STEP 3

Cover the roof on the frame ,and attach it by the bungee balls properly ,take care of the tension of the bungee balls ,for if you use too many on one side of tent ,it may too tight to tie the other side of it .

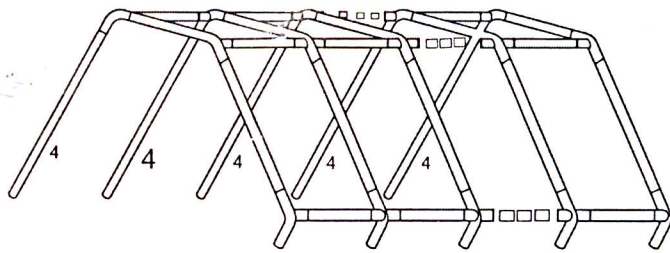

STEP 4

Attach the another 4 supported poles (4) to the joints (A,B), built-up the framework ,use the long peg to fix each pole into the ground and use the hook to fix the leg cover to the leg .

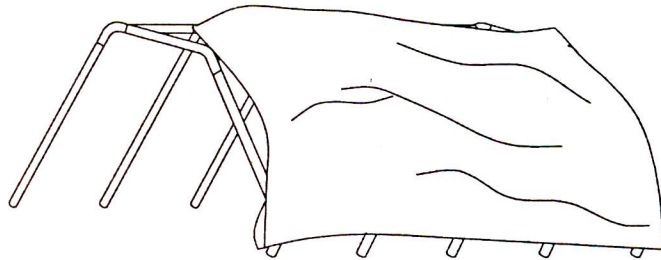

Assemble manual

STEP 5

Attach the another 4 supported poles (4) to the joints (A,B), built-up the framework ,use the long peg to fix each pole into the ground and use the hook to fix the cover to the leg .

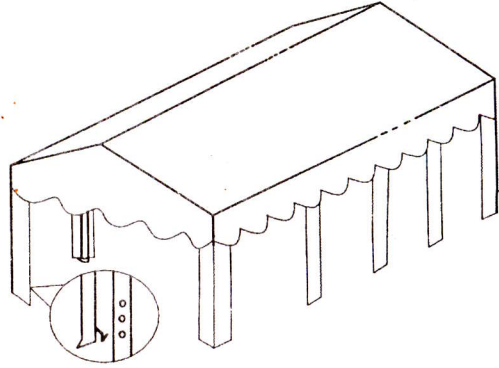

STEP 6

Spread the wall panel and door panel attach to framework by using the bungee cords clasping the frame to grommets that is construct over the wall panel and door panel to ensure stability. Also use the short pegs to fix the doors to the ground .

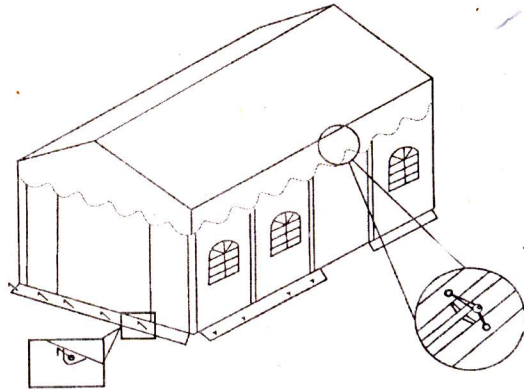

STEP 7



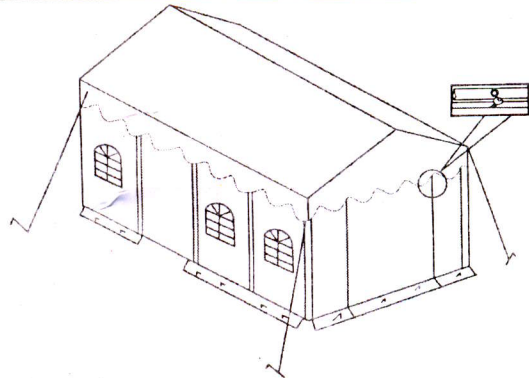



The Guy lines clasp to each corner of tent and another end of line fix to ground by pegs.



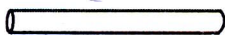
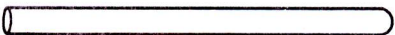
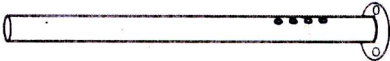
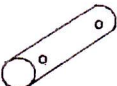
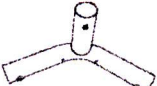

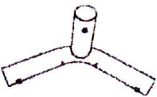
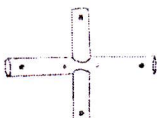
Warning:

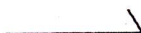
1. In order to avoid being rusted by air ,oil is covered on the surface of the pipes ,before set up the tent ,please remove the oil carefully frist to keep the cover clean.
 2. Take note that the tent needs to be handled carefully to avoid damage.
 3. Do not force the frame as they may be damage in the process.
 4. Tents are meant as temporary shelter and must be evacuated under extreme weather conditions.
 5. The windows maybe a little bit sticky to each other ,when you unfold the windows ,please do as softly as you can .Or the windows maybe crack during the process.
- Please select a suitable site for the tent to avoid the damage to underground sprinkler systems, water, gas or electrical lines.

5M PVC PARTYTENT INSTRUCTION

ARTS NO.	Reference image	5x4m	5x6m	5x8m	5x10m	5x12m
1		6	8	10	12	14
2		12	17	22	27	32
4		6	8	10	12	14
5		6	8	10	12	14
6		4	4	4	4	4
7		2	4	6	8	10
8		2	2	2	2	2
9		2	3	4	5	6
		4	4	4	4	4
		6	8	10	12	14
		30	36	42	48	54
		42	58	74	90	106
		70	88	106	124	142

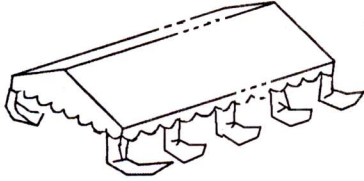
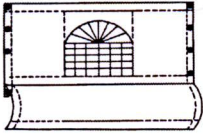
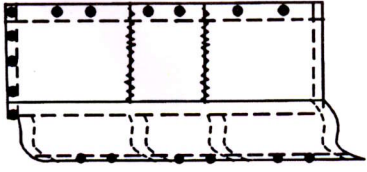
		22	22	22	22	22
		4	4	4	4	4
		6	8	10	12	14
		1	1	1	1	1
		4	6	8	10	12
		2	2	2	2	2

DANCOVER®

Big or Small we cover it all...

Nordre Strandvej 119 G
 3150 Hellebæk
 Denmark
 Tel.: (+45) 70 26 76 20
 Fax: (+45) 70 26 76 30

WWW.DANCOVERSHOP.COM